

CW vertical Section: 1:50

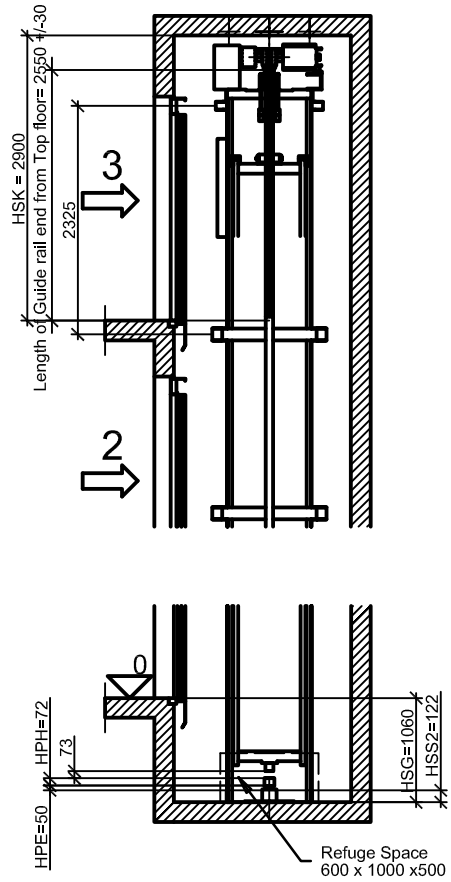

Car vertical Section: 1:50

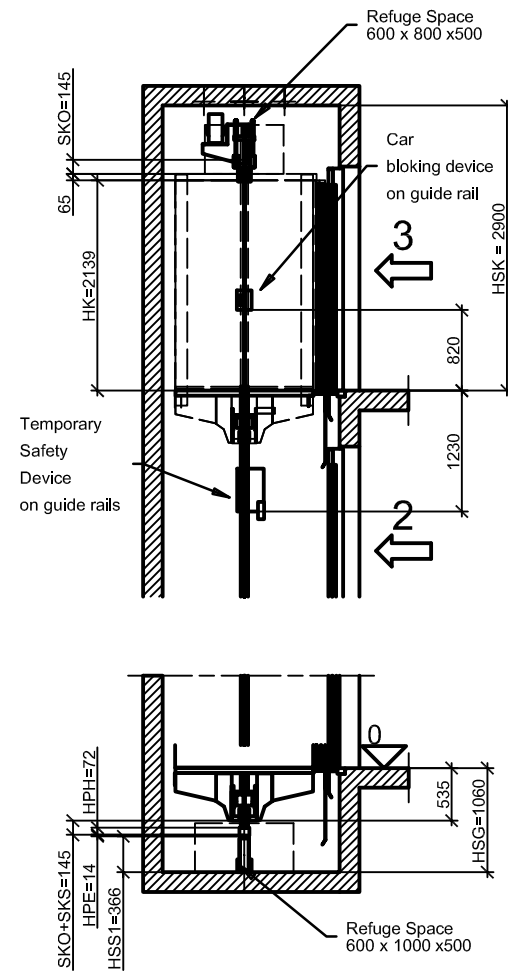

Master Dispo

Schindler 3300 / 5300

GQ (kg): 675
 BK (mm): 1200
 TK (mm): 1400
 BT (mm): 900
 TSW (mm): 115



Drawn	J. M. Asion	15/09/2005	A3
Released			

Plan No.
 Car & Counterweight vertical section